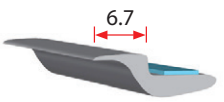
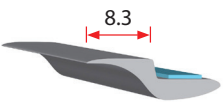
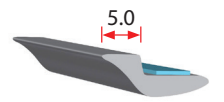
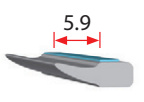
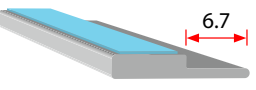
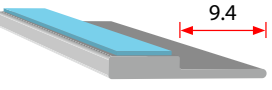
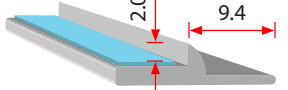
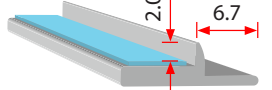

Self Adhesive Universal Moulds - Sponge

<p>UNI-9 POPULAR</p>  <p>VE Commodore, Starlet Rear & 1/4 glass, Mirage Rear & 1/4's. 94 Civic Hatch Rear, Lancer 1/4 glass, Self Adhesive Rubber Sponge Mould.</p> <p style="text-align: right;">15m Roll</p>	<p>UNI-9A POPULAR</p>  <p>As UNI-9, 1.5mm wider than UNI-9</p> <p style="text-align: right;">15m Roll</p>	<p>UNI-5</p>  <p>Dualis Rear Underside Mould</p> <p style="text-align: right;">15m Roll</p>	<p>UNI-7</p>  <p>Mazda 3, 6 Rear and Others. Self Adhesive Rubber Sponge Moulding</p> <p style="text-align: right;">15m Roll</p>
--	---	---	---

Self Adhesive Universal Moulds - Solid

<p>BA1 POPULAR</p>  <p>Self Adhesive Mould for BA Falcon Front, Rear & Late Vectra. Passat & Other Vehicles.</p> <p style="text-align: right;">15m Roll</p>	<p>BA2 POPULAR</p>  <p>Same as BA1 but with 3mm Wider Flap.</p> <p style="text-align: right;">15m Roll</p>	<p>BA3 NEW</p>  <p>Same as BA2 but with 2mm raised lip for easy locating.</p> <p style="text-align: right;">15m Roll</p>	<p>BA4 NEW</p>  <p>Same as BA1 but with 2mm raised lip for easy locating.</p> <p style="text-align: right;">15m Roll</p>
---	--	---	--

BA UNIVERSAL MOULDS

NEW

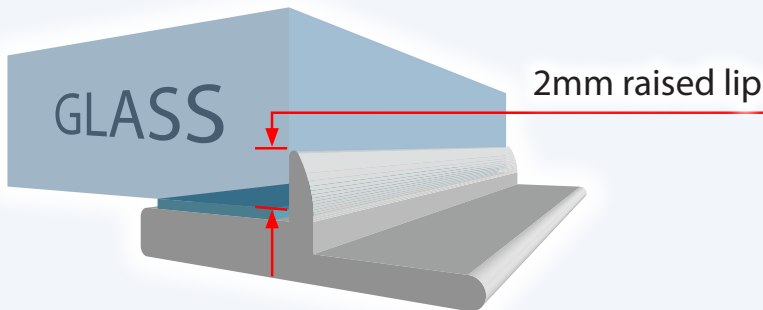

New BA3 & BA4 Uni Moulds have a 2mm raised lip to perfectly align to the edge of the glass.

Universal Self Adhesive Under Glass Moulds

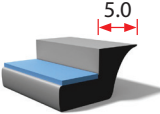
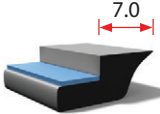
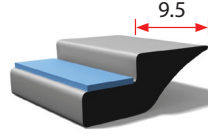

<p>PUGM MOULDS</p> <p>PUGM moulds are made of an extremely flexible sponge rubber material, especially useful for glass with tight corners.</p> <p>Clear Hi-Bond Adhesive.</p> <p>Blends with Frit / Ceramic Bond.</p>	<p>PUGM2</p>  <p>With Clear Hi-Bond Tape</p> <p style="text-align: right;">23m Roll</p>	<p>PUGM3</p>  <p>With Clear Hi-Bond Tape</p> <p style="text-align: right;">23m Roll</p>	<p>PUGM6</p>  <p>With Clear Hi-Bond Tape</p> <p style="text-align: right;">23m Roll</p>
---	--	---	--